

DZD1

NO FJ 20200525  
1.0  
2020.5.21

|              |       |    |
|--------------|-------|----|
| <b>1</b>     | ..... | 1  |
| <b>1.1</b>   | ..... | 1  |
| <b>1.2</b>   | ..... | 1  |
| <b>2</b>     | ..... | 2  |
| <b>3</b>     | ..... | 2  |
| <b>3.1</b>   | ..... | 2  |
| <b>3.2</b>   | ..... | 3  |
| <b>3.2.1</b> | ..... | 3  |
| <b>3.2.2</b> | ..... | 3  |
| <b>3.2.3</b> | ..... | 4  |
| <b>3.3</b>   | ..... | 5  |
| <b>3.3.1</b> | ..... | 5  |
| <b>3.3.2</b> | ..... | 6  |
| <b>3.3.3</b> | ..... | 6  |
| <b>3.3.4</b> |       |    |
| <b>4</b>     | ..... | 8  |
| <b>4.1</b>   | ..... | 8  |
| <b>4.2</b>   | ..... | 8  |
| <b>4.2.1</b> | ..... | 8  |
| <b>4.2.2</b> | ..... | 8  |
| <b>4.2.3</b> | ..... | 9  |
| <b>5</b>     | ..... | 9  |
| <b>6</b>     | ..... | 10 |



2

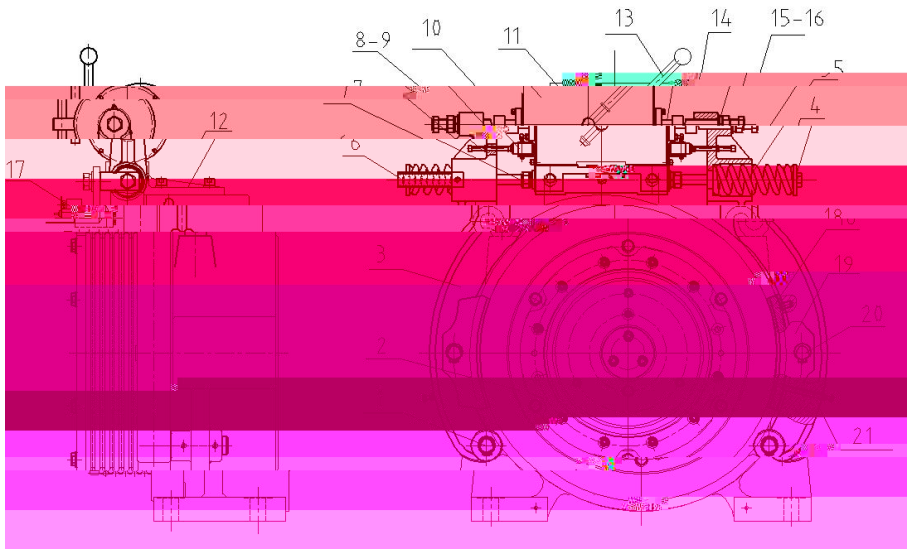

|   |     |    |  |    |    |
|---|-----|----|--|----|----|
| 1 |     | 8  |  | 15 |    |
| 2 | ( ) | 9  |  | 16 | 17 |
| 3 |     | 10 |  | 17 |    |
| 4 |     | 11 |  | 18 |    |
| 5 |     | 12 |  | 19 |    |
| 6 |     | 13 |  | 20 |    |
| 7 | 5   | 14 |  | 21 |    |

1

3

3.1

6~8

1

- 1
- 2
- 3
- 4
- 5
- 6
- 7
- 8

3.2.1

3mm

80

1



- 
- 

6

3.2

3.2.1

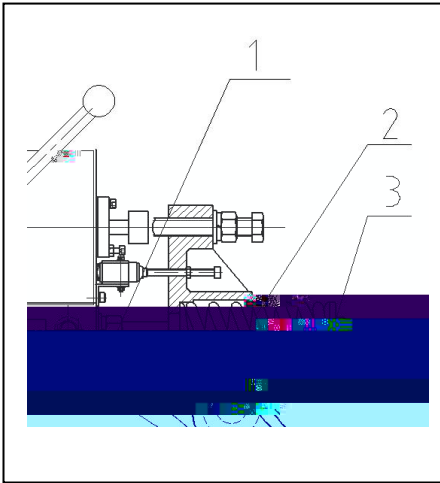

- 1
  - 2
  - 3
- 1

2



3



3

3.2.2

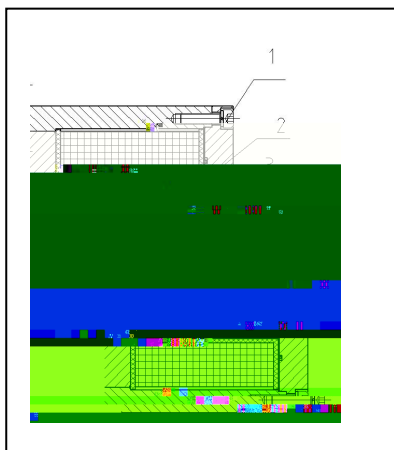

- 1
  - 2
  - 3
  - 4
- 1
- 3

3.2.3

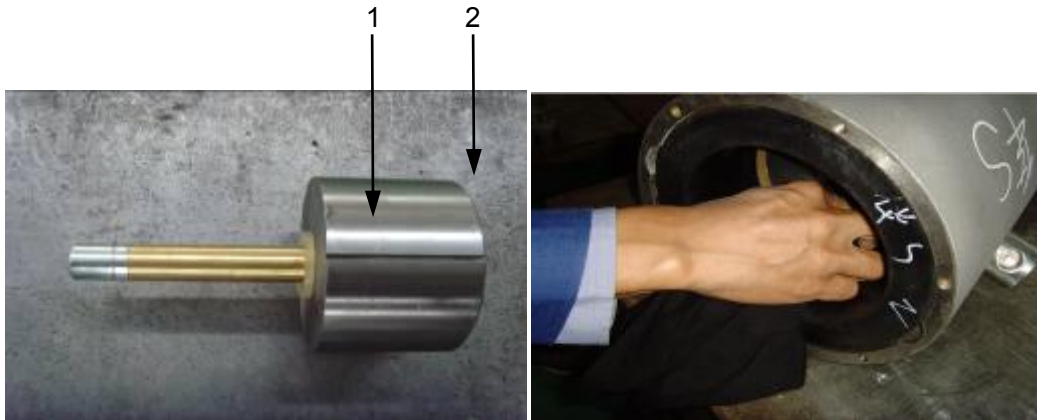

5

6

1  
2

6

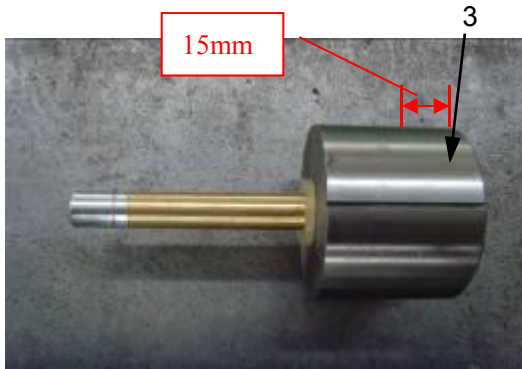

7

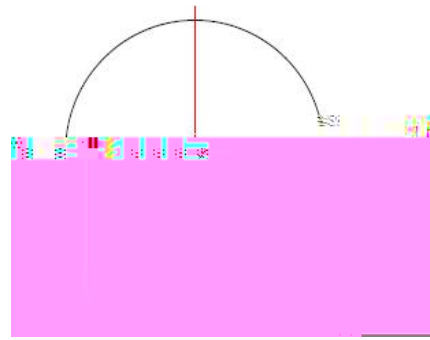

8

3

7

15

70%

8

0.6

180

0.6

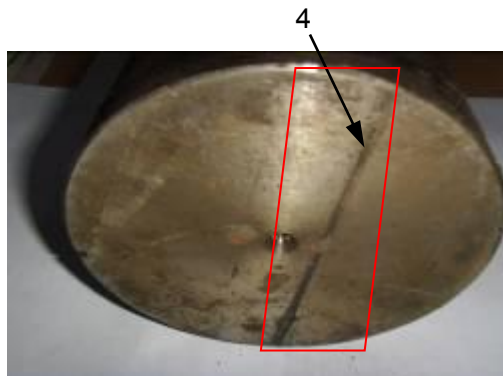

8

4

8

5



9

10

5

P

680

10

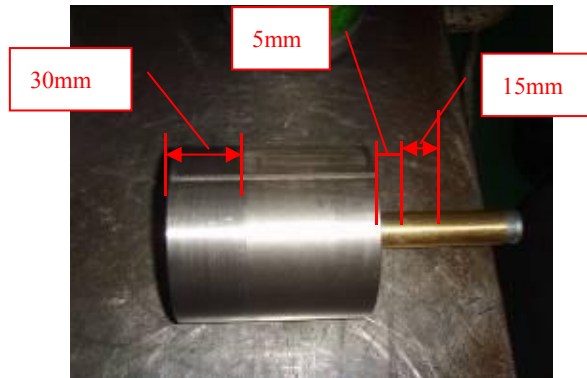

12

6

12 30

12 15

0.05



3.3

3.3.1

3.2.1



3.3.2



•

•

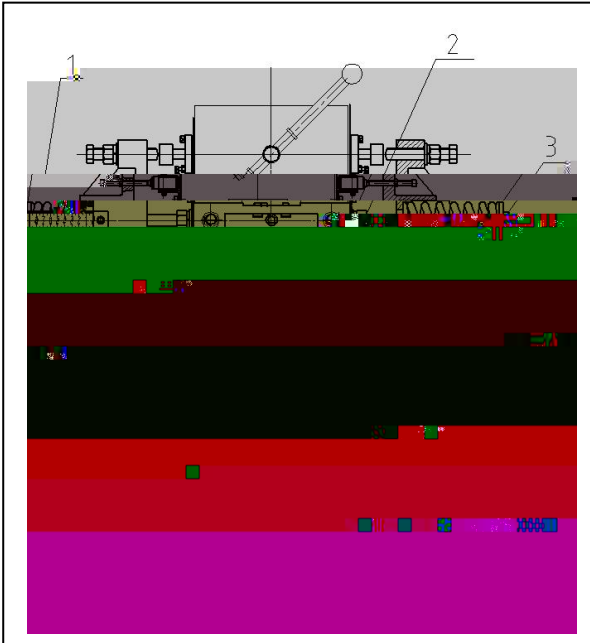

|   |       |         |
|---|-------|---------|
| 1 |       | 1       |
|   | 1 1.5 |         |
| 2 |       | 2,3     |
| 3 |       |         |
| 4 |       |         |
|   | 3     | 3.3.3   |
| 5 |       | 4.2.3 " |
|   |       | "       |
| 6 |       |         |

3.3.3



•

•

6

3

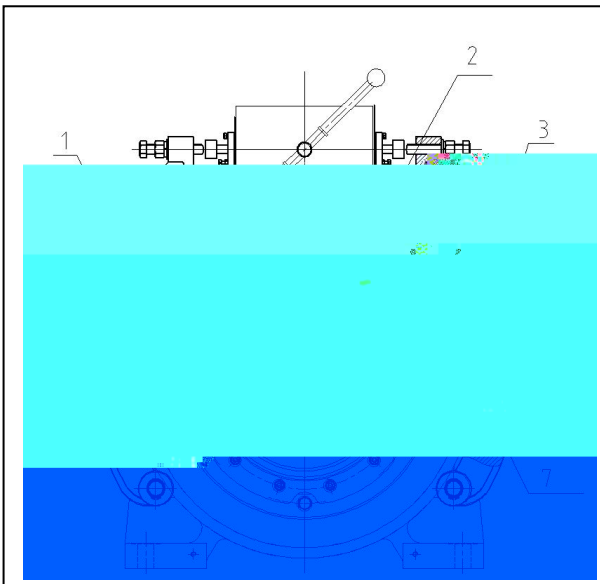

|   |       |     |
|---|-------|-----|
| 1 |       | 1   |
|   | 1 1.5 |     |
|   |       | 2,3 |
| 2 |       |     |
| 3 |       | 7   |
|   |       |     |
|   |       | 6   |



4

6

5

4.2

3.3.4

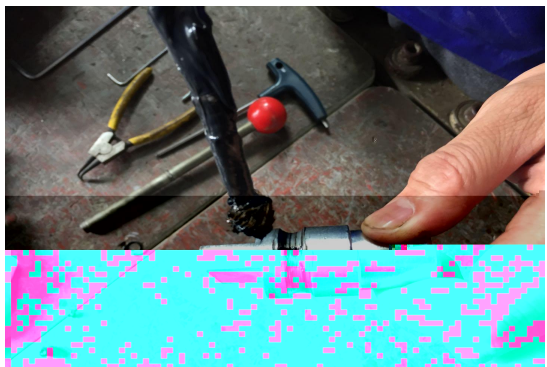
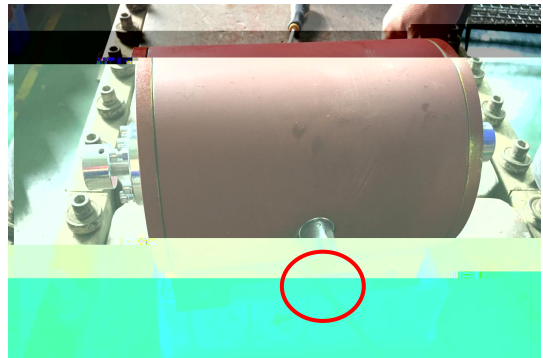

1

2 M5

3

4

5

6

7

4

4.1



4.2

4.2.1



4.2.3

0.2

4.2.2



2 1.25

**A B B A**

4.2.3

1 3 A  
2 ! )  
3 B(B )  
4 3 1  
5 4 1  
6 4  
7

DZD1

|  |   |          |
|--|---|----------|
|  | 1 | 1        |
|  | 2 | 2        |
|  | 3 | 3 80 DC  |
|  | 4 | 4 55 DC  |
|  | 5 | 5        |
|  | 6 | 6 110 DC |
|  | 7 | 7        |
|  | 1 | 1        |
|  | 2 | 2 80 DC  |
|  | 1 | 1        |
|  | 2 | 2        |
|  | 3 | 3        |
|  | 4 | 4        |
|  |   |          |

6

DZD1

---

DZD1